

PV Grid Tie Inverter

# Solis 4G Single Phase Inverter

Installation and Operation Manual

Solis-1P6K3-4G, Solis-1P7K-4G, Solis-1P8K-4G, Solis-1P9K-4G, Solis-1P10K-4G



Ginlong Technologies Co., Ltd.

No. 57 Jintong Road, Binhai Industrial Park, Xiangshan, Ningbo,  
Zhejiang, 315712, P.R.China.

Tel: +86 (0)574 6578 1806

Fax: +86 (0)574 6578 1606

Email: info@ginlong.com

Web: www.ginlong.com

Please adhere to the actual products in case of any discrepancies in this user manual.

If you encounter any problem on the inverter, please find out the inverter S/N  
and contact us, we will try to respond to your question ASAP.



© Ginlong Technologies Co., Ltd.

# Contents

1. Introduction .....	3
1.1 Product Description .....	3
1.2 Packaging .....	4
2. Safety Instructions .....	5
2.1 Safety Symbols .....	5
2.2 General Safety Instructions .....	5
2.3 Notice For Use .....	6
3. Overview .....	7
3.1 Front Panel Display .....	7
3.2 LED Status Indicator Lights .....	7
3.3 Keypad .....	8
3.4 LCD .....	8
4. Installation .....	9
4.1 Select Location for the Inverter .....	9
4.2 Mounting the Inverter .....	11
4.3 Electrical Connections .....	13
4.3.1 Connect PV side of inverter .....	13
4.3.2 Connect grid side of inverter .....	16
4.3.3 External ground connection .....	18
4.3.4 Max. overcurrent protection device (OCPD)...	18
4.3.5 Inverter monitoring connection .....	19
5. Start & Stop .....	20
5.1 Start the Inverter .....	20
5.2 Stop the Inverter .....	20
6. Operation .....	21
6.1 Main Menu .....	21
6.2 Information .....	21
6.2.1 Lock screen .....	22
6.3 Settings .....	23
6.3.1 Set Time .....	23
6.3.2 Set Address .....	23

# Contents

6.4 Advanced Info.	24
6.4.1 Alarm Message	24
6.4.2 Running Message	24
6.4.3 Version	25
6.4.4 Daily Energy	25
6.4.5 Monthly Energy	25
6.4.6 Yearly Energy	26
6.4.7 Daily Record	26
6.4.8 Communication Data	26
6.4.9 Warning Message	26
6.5 Advanced Settings	27
6.5.1 Select Standard	27
6.5.2 Grid ON/OFF	28
6.5.3 Clear Energy	28
6.5.4 Reset Password	29
6.5.5 Power Control	29
6.5.6 Calibrate Energy	29
6.5.7 Special Settings	30
6.5.8 STD. Mode Settings	30
6.5.9 Restore Settings	30
6.5.10 HMI Update	30
6.5.11 External EPM Set	31
6.5.12 Restart HMI	31
6.5.13 Debug Parameter	31
6.5.14 DSP Update	31
6.5.15 Power Parameter	32
6.6 AFCI function	33
7. Maintenance	34
8. Troubleshooting	34
9. Specifications	37
10. Appendix	42
10.1 Grid standard selection guide	42

# 1. Introduction

## 1.1 Product Description

Single phase 4G series inverter contain 5 models which are listed below:  
Solis-1P6K3-4G, Solis-1P7K-4G, Solis-1P8K-4G, Solis-1P9K-4G, Solis-1P10K-4G

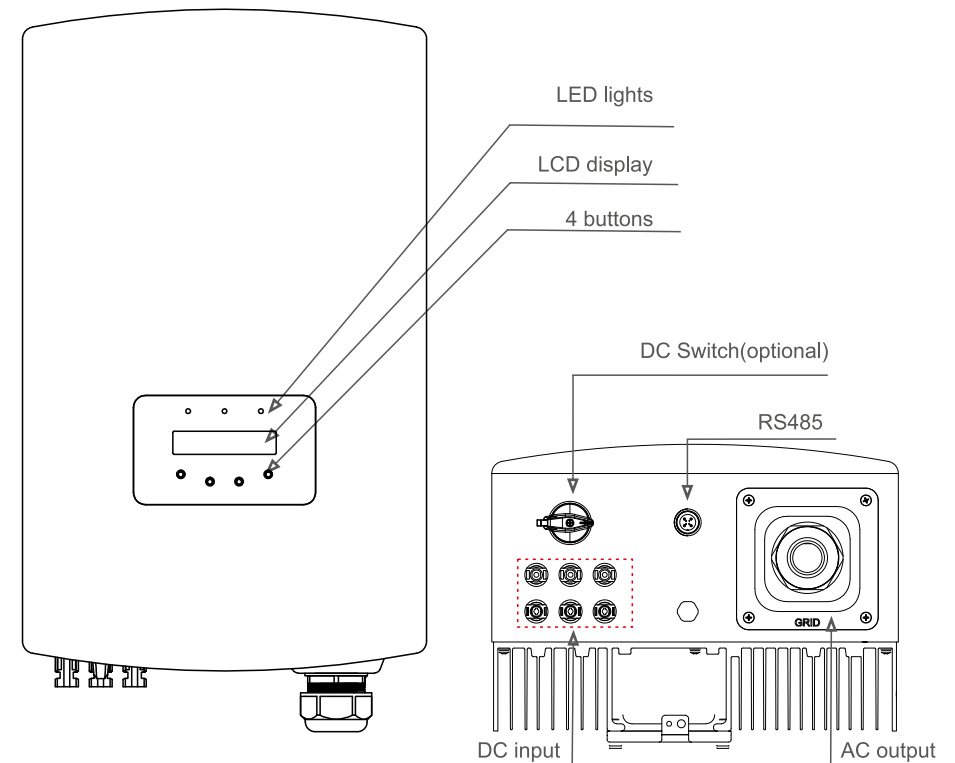

▲ Figure 1.1 Front side view

▲ Figure 1.2 Bottom side view

# 1. Introduction

## 1.2 Packaging

When you receive the inverter, ensure that all the parts listed below are included:

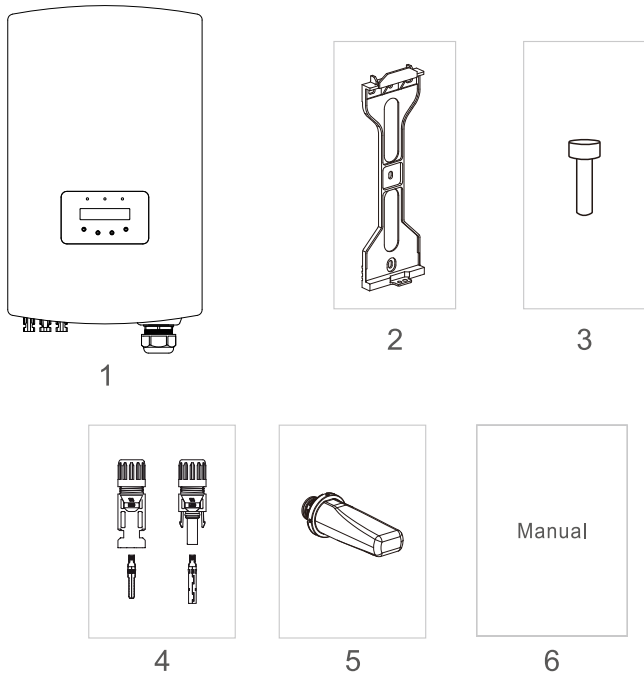

Part #	Description	Number
1	PV grid tie inverter	1
2	Wall/pole bracket	1
3	Locking screws	1
4	DC connector	3 pairs
5	WiFi/GPRS Stick ( Optional )	1
6	Manual	1

▲ Table 1.1 Parts list

# 2. Safety Instructions

Improper use may result in potential electric shock hazards or burns. This manual contains important instructions that should be followed during installation and maintenance. Please read these instructions carefully before use and keep them for future reference.

## 2.1 Safety Symbols

Safety symbols used in this manual, which highlight potential safety risks and important safety information, are listed as follows:



**WARNING:**

WARNING symbol indicates important safety instructions, which if not correctly followed, could result in serious injury or death.



**NOTE:**

NOTE symbol indicates important safety instructions, which if not correctly followed, could result in some damage or the destruction of the inverter.



**CAUTION:**

CAUTION, RISK OF ELECTRIC SHOCK symbol indicates important safety instructions, which if not correctly followed, could result in electric shock.



**CAUTION:**

CAUTION, HOT SURFACE symbol indicates safety instructions, which if not correctly followed, could result in burns.

## 2.2 General Safety Instructions



**WARNING:**

Please don't connect PV array positive(+) or negative(-) to ground, it could cause serious damage to the inverter.



**WARNING:**

Electrical installations must be done in accordance with the local and national electrical safety standards.

## 2. Safety Instructions

## 3. Overview



### WARNING:

To reduce the risk of fire, over-current protective devices (OCPD) are required for circuits connected to the Inverter. The DC OCPD shall be installed per local requirements. All photovoltaic source and output circuit conductors shall have disconnects that comply with the NEC Article 690, Part II. All Solis single phase inverters feature an integrated DC switch.



### CAUTION:

Risk of electric shock. Do not remove cover. There is no user serviceable parts inside. Refer servicing to qualified and accredited service technicians.



### CAUTION:

The PV array (Solar panels) supplies a DC voltage when they are exposed to sunlight.



### CAUTION:

Risk of electric shock from energy stored in capacitors of the Inverter. Do not remove cover for 5 minutes after disconnecting all power sources (service technician only). Warranty may be voided if the cover is removed without unauthorized .



### CAUTION:

The surface temperature of the inverter can reach up to 75°C (167 F). To avoid risk of burns, do not touch the surface of the inverter while it's operating. Inverter must be installed out of the reach of children.

### 2.3 Notice For Use

The inverter has been constructed according to the applicable safety and technical guidelines. Use the inverter in installations that meet the following specifications ONLY:

1. Permanent installation is required.
2. The electrical installation must meet all the applicable regulations and standards.
3. The inverter must be installed according to the instructions stated in this manual.
4. The inverter must be installed according to the correct technical specifications.
5. To startup the inverter, the Grid Supply Main Switch (AC) must be switched on, before the solar panel's DC isolator shall be switched on. To stop the inverter, the Grid Supply Main Switch (AC) must be switched off before the solar panel's DC isolator shall be switched off.

### 3.1 Front Panel Display



▲ Figure 3.1 Front Panel Display

### 3.2 LED Status Indicator Lights

There are three LED status indicator lights in the front panel of the inverter. Left LED: POWER LED (red) indicates the power status of the inverter. Middle LED: OPERATION LED (green) indicates the operation status. Right LED: ALARM LED (yellow) indicates the alarm status. Please see Table 3.1 for details

Light	Status	Description
● POWER	ON	The inverter can detect DC power
	OFF	No DC power or low DC power
● OPERATION	ON	The inverter is operating properly.
	OFF	The inverter has stopped to supply power.
	FLASHING	The inverter is initializing.
● ALARM	ON	Alarm or fault condition is detected.
	OFF	The inverter is operating without fault or alarm.

▲ Table 3.1 Status Indicator Lights

## 3. Overview

### 3.3 Keypad

There are four keys in the front panel of the Inverter(from left to right): ESC, UP, DOWN and ENTER keys. The keypad is used for:

- Scrolling through the displayed options (the UP and DOWN keys);
- Access to modify the adjustable settings (the ESC and ENTER keys).

### 3.4 LCD

The two-line Liquid Crystal Display (LCD) is located on the front panel of the Inverter, which shows the following information:

- Inverter operation status and data;
- Service messages for operator;
- Alarm messages and fault indications.

## 4. Installation

### 4.1 Select a Location for the Inverter

To select a location for the inverter, the following criteria should be considered:



#### **WARNING: Risk of fire**

Despite careful construction, electrical devices can cause fires.

- Do not install the inverter in areas containing highly flammable materials or gases.
- Do not install the inverter in potentially explosive atmospheres.
- Do not install in small closed spaces where air can not circulate freely. To avoid overheating, always make sure the flow of air around the inverter is not blocked.
- Exposure to direct sunlight will increase the operational temperature of the inverter and may cause output power limiting. Ginlong recommends inverter installed to avoid direct sunlight or raining.
- To avoid over heating ambient air temperature must be considered when choosing the inverter installation location. Ginlong recommends using a sun shade minimizing direct sunlight when the ambient air temperature around the unit exceeds 104°F/40°C.

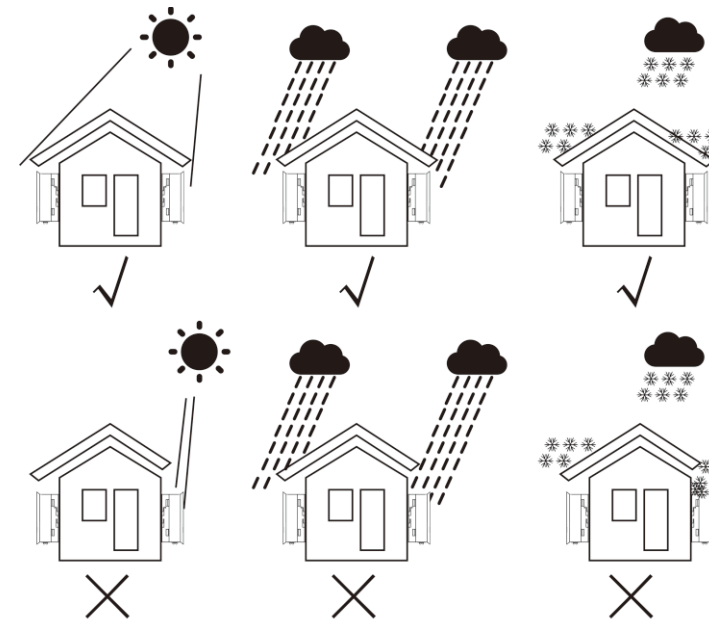

▲ Figure 4.1 Recommended installation position

# 4. Installation

- Install on a wall or strong structure capable of bearing the weight.
- Install vertically with a maximum incline of  $\pm 5^\circ$ . If the mounted inverter is tilted to an angle greater than the maximum noted, heat dissipation can be inhibited, and may result in less than expected output power.
- When 1 or more inverters are installed in one location, a minimum 12inches clearance should be kept between each inverter or other object. The bottom of the inverter should be 20inches clearance to the ground.

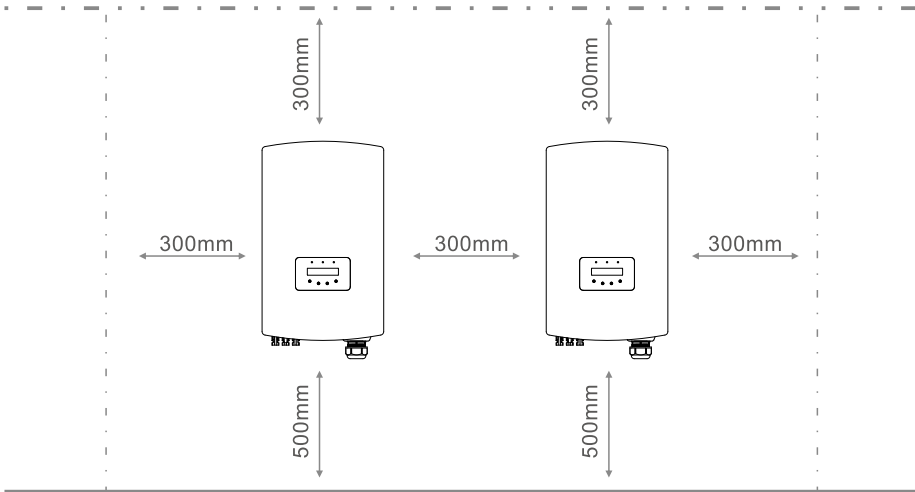

▲ Figure 4.2 Inverter Mounting clearance

- Visibility of the LED status indicator lights and the LCD located at the front panel of the inverter should be considered.
- Adequate ventilation must be provided if the inverter is to be installed in a confined space.



**NOTE:**

Nothing should be stored on or placed against the inverter.

# 4. Installation

## 4.2 Mounting the Inverter

Dimensions of mounting bracket:

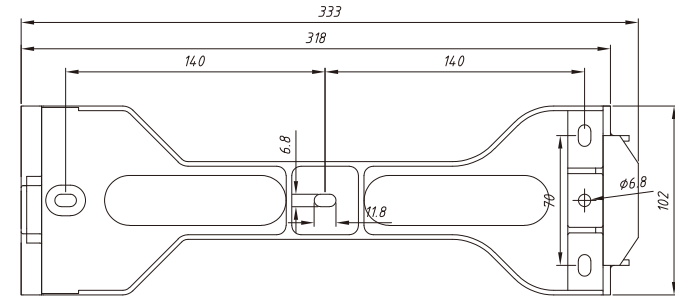

▲ Figure 4.3 Inverter wall mounting

Please see Figure 4.4 and Figure 4.5 for instruction on mounting the inverter to a wall or pillar. The inverter shall be mounted vertically. The steps to mount the inverter are listed below:

1. According to the figure 4.2, select the mounting height of the bracket and mark the mounting holes. For brick walls, the position of the holes should be suitable for the expansion bolts.

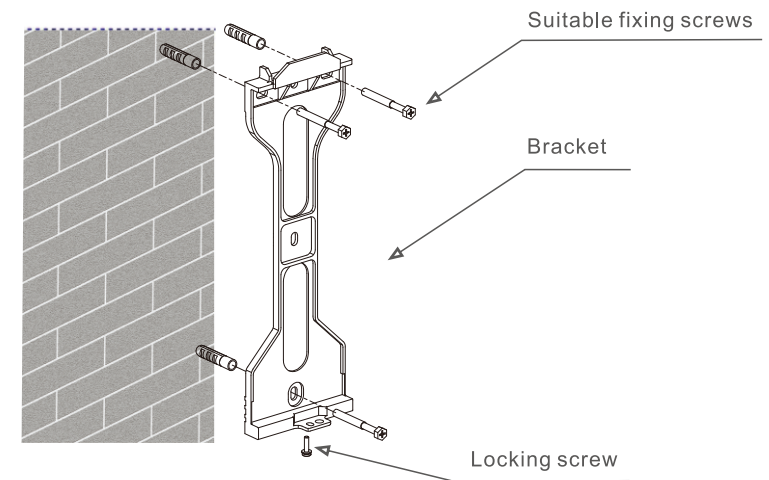

▲ Figure 4.4 Inverter wall mounting

# 4. Installation

# 4. Installation

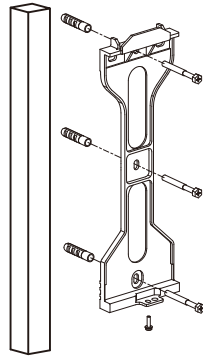

▲ Figure 4.5 Inverter pillar mounting

2. Make sure the bracket is horizontal and the mounting holes (in Figure 4.4 and Figure 4.5) are marked correctly. Drill the holes into the wall or pillar at your marks.
3. Use the suitable screws to fix the bracket to the wall.



**WARNING:**  
The inverter must be mounted vertically.

4. Lift up the inverter (be careful to avoid body strain), and align the back bracket on the inverter with the convex section of the mounting bracket. Hang the inverter on the mounting bracket and make sure the inverter is secure (see Figure 4.6)

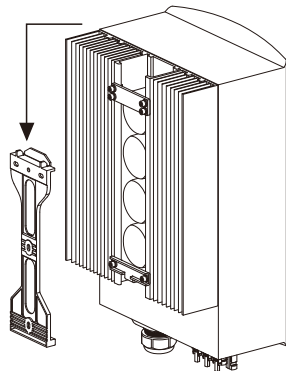

▲ Figure 4.6 Wall Mount Bracket

5. Use screws to fix the bottom of the inverter to the mount bracket.

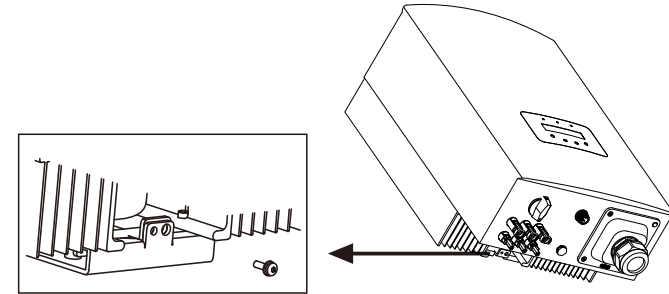

▲ Figure 4.7 Fix the inverter

There are two holes at the bottom of bracket, one to fix the inverter, another for the lock. **The diameter of the lock should be less than 0.27in (7mm).**

## 4.3 Electrical Connections

### 4.3.1 Connect PV side of inverter

The electrical connection of the inverter must follow the steps listed below:

1. Switch the Grid Supply Main Switch (AC) OFF.
2. Switch the DC Isolator OFF.
3. Assemble PV input connector to the Inverter.



Before connecting inverter, please make sure the PV array open circuit voltage is within the limit of the inverter

#### Maximum 600Voc for

Solis-1P6K3-4G Solis-1P7K-4G

Solis-1P8K-4G Solis-1P9K-4G Solis-1P10K-4G



Please don't connect PV array positive or negative pole to the ground, it could cause serious damages to the inverter



# 4. Installation



Before connection, please make sure the polarity of the output voltage of PV array matches the “DC+” and “DC-” symbols.

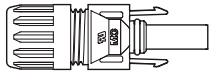

▲ Figure 4.8 DC+ Connector

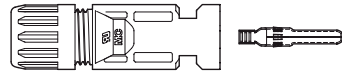

▲ Figure 4.9 DC- Connector



Please use approved DC cable for PV system.

Cable type	Cross section	
	Range	Recommended value
Industry generic PV cable (model:PV1-F)	4.0~6.0 (12~10AWG)	4.0 (12AWG)

▲ Table 4.1 DC cable

The steps to assemble the DC connectors are listed as follows:

i) Strip off the DC wire for about 7mm, Disassemble the connector cap nut.

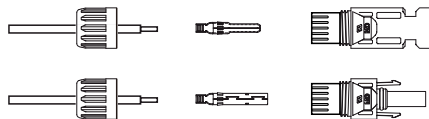

▲ Figure 4.10 Disassemble the Connector Cap nut

ii) Insert the wire into the connector cap nut and contact pin.

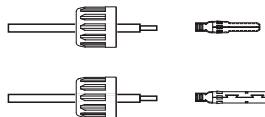

▲ Figure 4.11 Insert the Wire into the Connector Cap nut and contact pin

# 4. Installation

iii) Crimp the contact pin to the wire using a proper wire crimper.



▲ Figure 4.12 Crimp the contact pin to the wire

iv) Insert the contact pin to the top part of the connector and screw up the cap nut to the top part of the connector.

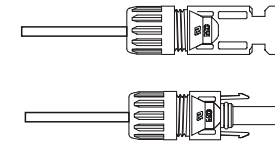

▲ Figure 4.13 Connector with Cap nut Screwed on

v) Then connect the DC connectors to the inverter. Small click will confirm connection.

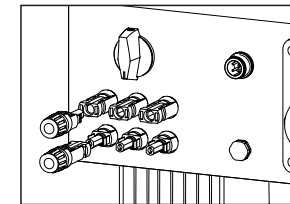

▲ Figure 4.14 Connect the DC Connectors to the Inverter

# 4. Installation

# 4. Installation



**Caution:**

If DC inputs are accidentally reversely connected or inverter is faulty or not working properly, it is NOT allowed to turn off the DC switch as it will damage the inverter and even leads to a fire disaster.

The correct actions are:

\*Use a clip-on ammeter to measure the DC string current

\*If it is above 0.5A, please wait for the solar irradiance reduces until the current decreases to below 0.5A.

\*Only after the current is below 0.5A,

you are allowed to turn off the DC switches and disconnect the PV strings. Please note that any damages due to wrong operations are not covered in the device warranty.

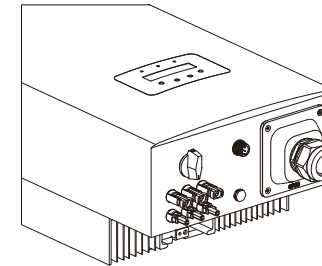

▲ Figure 4.16 Disassemble AC terminal cover

C) Insert the 3 cables into AC terminal and use the slotted screwdriver to tight the screws. The torque is 2-2.5Nm. (as shown in figure 4.17)

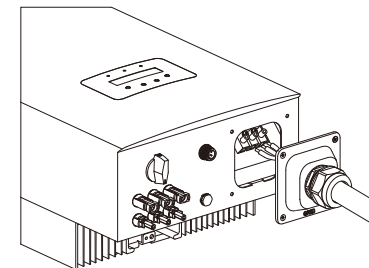

▲ Figure 4.17 Connect cable to AC terminal



**WARNING:**

Please do not put the insulating layer of the cable in to the terminal when tight the screws, otherwise it will cause poor contact.

D) Push the AC terminals along the rail to the inside of the inverter then tighten the screw under rack. Lock the 4 screws of AC terminal and tighten the cap nut of AC terminal. (as shown in figure 4.18)

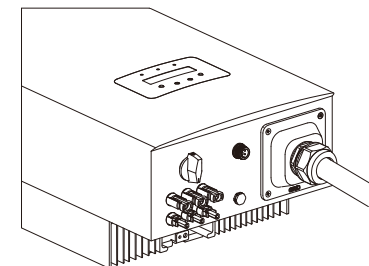

▲ Figure 4.18 Tighten the AC terminal

## 4.3.2 Connect grid side of inverter

For all AC connections, 10- 25mm<sup>2</sup> 105 °C cable is required to be used. Please make sure the resistance of cable is lower than 1.5ohm. If the wire is longer than 20m, it's recommended to use 16-25mm<sup>2</sup> cable.

The steps to assemble the AC grid terminals are listed as follows:

A) Strip the end of AC cable outer insulating jacket about 60mm then strip the end of each wire about 10mm. (as shown in figure 4.15)

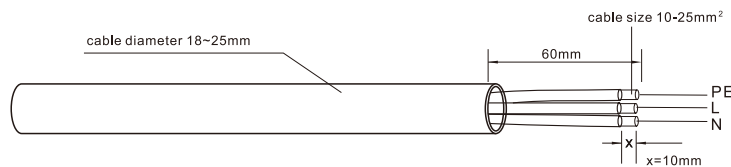

▲ Figure 4.15 Stripped AC Wires



Additional explanation:

If the diameter of the protective layer of the AC cable is less than the recommended (18-25mm) it should be spirally wounded the protective.

B) Disassemble the 4 screws on the AC terminal cover and take out the cover. Disassemble the screw under terminal rack and Pull out the terminal (as shown in figure 4.16)

# 4. Installation

# 4. Installation

## 4.3.3 External ground connection

An external ground connection is provided at the right side of inverter. Prepare OT terminals: M4. Use proper tooling to crimp the lug to the terminal. Connect the OT terminal with ground cable to the right side of inverter. The torque is 20 in-lbs (2N.m).

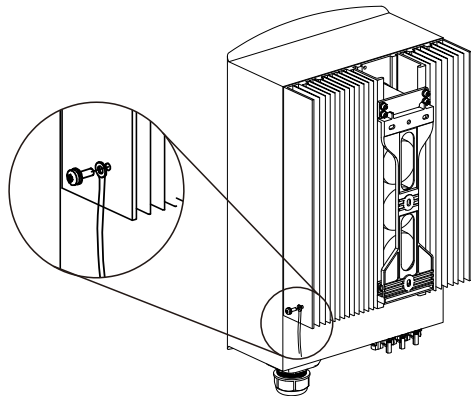

▲ Figure 4.19 Connect the external grounding conductor

## 4.3.4 Max. over current protection device (OCPD)

To protect the inverter's AC grid connection conductors, Solis recommends installing breakers that will protect against overcurrent. The following table defines OCPD ratings for the Solis 6-10kW single phase inverters.

Inverter	Rated voltage(V)	Rated output current (A)	Current for protection device (A)
Solis-1P6K3-4G	220/230	27.3/26.1	40
Solis-1P7K-4G	220/230	31.8/30.4	40
Solis-1P8K-4G	220/230	36.4/34.8	60
Solis-1P9K-4G	220/230	40.9/39.1	60
Solis-1P10K-4G	220/230	45.5/43.5	60

▲ Table 4.3 Rating of grid OCPD

## 4.3.5 Inverter monitoring connection

The inverter can be monitored via Wi-Fi or GPRS. All Solis communication devices are optional (Figure 4.20). For connection instructions, please refer to the Solis Monitoring Device installation manuals.

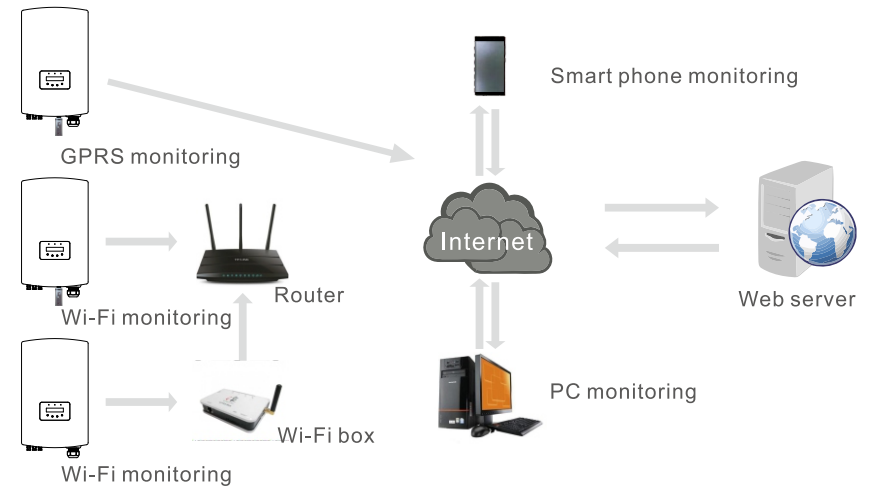

▲ Figure 4.20 Wi-Fi communication function

# 5. Start & Stop

# 6. Operation

## 5.1 Start the Inverter

To start up the Inverter, it is important that the following steps are strictly followed:

1. Switch the grid supply main Switch (AC) ON first.
2. Switch the DC switch ON. If the voltage of PV arrays are higher than start up voltage, the inverter will turn on. The red LED power will light.
3. When both the DC and the AC sides supply to the inverter, it will be ready to generate power. Initially, the inverter will check both its internal parameters and the parameters of the AC grid, to ensure that they are within the acceptable limits. At the same time, the green LED will flash and the LCD displays the information of INITIALIZING.
4. After 30-300 seconds (depending on local requirement), the inverter will start to generate power. The green LED will be on continually and the LCD displays GENERATING.



### WARNING:

Do not touch the surface when the inverter is operating. It may be hot and cause burns.

## 5.2 Stop the Inverter

To stop the Inverter, the following steps must be strictly followed:

1. Switch the Supply Main Switch (AC) OFF.
2. Wait 30 seconds. Switch the DC Switch OFF. All the LEDs of the inverter will be off in one minute.

During normal operation, the display alternately shows the power and the operation status with each screen lasting for 10 seconds (see Figure 6.1). Screens can also be scrolled manually by pressing the UP and DOWN keys. Press the ENTER key to access to the Main Menu.

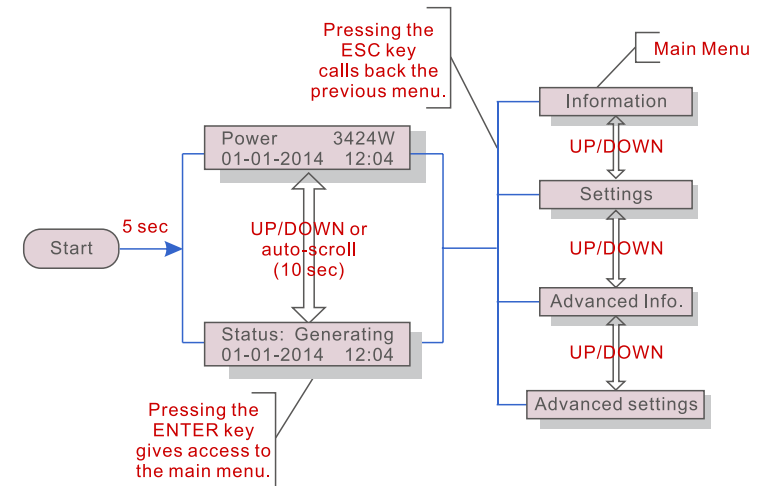

▲ Figure 6.1 Operation Overview

## 6.1 Main Menu

There are four submenus in the Main Menu (see Figure 6.1):

1. Information
2. Settings
3. Advanced Info.
4. Advanced Settings

## 6.2 Information

The Solis Single Phase 4G Inverter main menu provides access to operational data and information. The information is displayed by selecting "Information" from the menu and then by scrolling up or down.

Display	Duration	Description
V_DC1 350.8V I_DC1 5.1A	10 sec	V_DC1: Shows input 01 voltage value. I_DC1: Shows input 01 current value.
V_DC3 350.8V I_DC3 5.1A	10 sec	V_DC3: Shows input 03 voltage value. I_DC3: Shows input 03 current value.
V_Grid 230.4V I_Grid 8.1A	10 sec	V_Grid: Shows the grid's voltage value I_Grid: Shows the grid's current value.
Status: Generating Power: 1488W	10 sec	Status: Shows instant status of the Inverter. Power: Shows instant output power value.
Grid Frequency F_Grid 60.06Hz	10 sec	F_Grid: Shows the grid's frequency value.
Total Energy 0258458 kwh	10 sec	Total generated energy value.
This Month: 0123kwh Last Month: 0123kwh	10 sec	This Month: Total energy generated this month. Last Month: Total energy generated last month.
Today: 15.1kwh Yesterday: 13.5kwh	10 sec	Today: Total energy generated today. Yesterday: Total energy generated yesterday.
Inverter SN 00000000000000	10 sec	Display series number of the inverter

▲ Table 6.1 Information list

## 6.2.1 Lock screen

Pressing the ESC key returns to the Main Menu. Pressing the ENTER key locks (Figure 6.2(a)) or unlocks (Figure 6.2 (b)) the screen.



(a)



(b)

▲ Figure 6.2 Locks and Unlocks the Screen of LCD

## 6.3 Settings

The following submenus are displayed when the Settings menu is selected:

- 1.Set Time
- 2.Set Address

### 6.3.1 Set Time

This function allows time and date setting. When this function is selected, the LCD will display a screen as shown in Figure 6.3.

NEXT=<ENT> OK=<ESC>  
01-01-2016 16:37

▲ Figure 6.3 Set Time

Press the UP/DOWN keys to set time and data. Press the ENTER key to move from one digit to the next (from left to right). Press the ESC key to save the settings and return to the previous menu.

### 6.3.2 Set Address

This function is used to set the address when muti inverters are connected to single monitor. The address number can be assigned from "01" to "99"(see Figure 6.4). The default address number of Solis Single Phase Inverter is "01".

YES=<ENT> NO=<ESC>  
Set Address: 01

▲ Figure 6.4 Set Address

Press the UP/DOWN keys to set the address. Press the ENTER key to save the settings. Press the ESC key to cancel the change and return to the previous menu.

# 6. Operation

# 6. Operation

## 6.4 Advanced Info - Technicians Only



### NOTE:

To access to this area is for fully qualified and accredited technicians only. Enter menu "Advanced Info." and "Advanced settings" (need password) .

Select "Advanced Info." from the Main Menu. The screen will require the password as below

```
YES=<ENT> NO=<ESC>
Password:0000
```

▲ Figure 6.5 Enter password

The default password is "0010". Please press "down" to move the cursor, press "up" to select the number.

After enter the correct password the Main Menu will display a screen and be able to access to the following information.

**1.Alarm Message 2. Running Message 3.Version 4. Daily Energy 5. Monthly Energy 6. Yearly Energy 7. Daily Record 8.Communication Data 9. Warning Message**

The screen can be scrolled manually by pressing the UP/DOWN keys. Pressing the ENTER key gives access to a submenu. Press the ESC key to return to the Main Menu.

### 6.4.1 Alarm Message

The display shows the 100 latest alarm messages (see Figure 6.6). Screens can be scrolled manually by pressing the UP/ DOWN keys. Press the ESC key to return to the previous menu.

```
Alarm001: OV-G-V
Time: 27-11 Data: 7171
```

▲ Figure 6.6 Alarm Message

### 6.4.2 Running Message

This function is for maintainece person to get running message such as internal temperature, Standard NO. etc.

Screens can be scrolled manually by pressing the UP/DOWN keys.

### 6.4.3 Version

The screen shows the model version and the software version of the Inverter .

```
Model: 08
Software Version: D20001
```

▲ Figure 6.7 Model Version and Software Version

### 6.4.4 Daily Energy

The function is for checking the energy generation for selected day.

```
YES=<ENT> NO=<ESC>
Select: 2020-01-01
```

▲ Figure 6.8 Select date for daily energy

Press DOWN key to move the cursor to day, month and year, press UP key to change the digit. Press Enter after the date is fixed.

```
2020-01-01: 051.3kWh
2020-01-02: 061.5kWh
```

▲ Figure 6.9 Daily energy

Press UP/DOWN key to move one date from another.

### 6.4.5 Monthly Energy

The function is for checking the energy generation for selected month.

```
YES=<ENT> NO=<ESC>
Select: 2020-01
```

▲ Figure 6.10 Select month for monthly energy

Press DOWN key to move the cursor, press UP key to change the digit. Press Enter after the month is fixed.

```
2020-02: 0510kWh
2020-01: 0610kWh
```

▲ Figure 6.11 Month energy

Press UP/DOWN key to move one date from another.

# 6. Operation

# 6. Operation

## 6.4.6 Yearly Energy

The function is for checking the energy generation for selected year.

```
YES=<ENT> NO=<ESC>  
Select: 2020
```

▲ Figure 6.12 Select year for yearly energy

Press DOWN key to move the cursor, press UP key to change the digit.

Press Enter after the year is fixed.

```
2020: 0017513kWh  
2019: 0165879kWh
```

▲ Figure 6.13 Yearly energy

Press UP/DOWN key to move one date from another.

## 6.4.7 Daily record

The screen shows history of changing settings. Only for maintenance personnel.

## 6.4.8 Communication Data

The screen shows the internal data of the Inverter (see Figure 6.14), which is for service technicians only.

```
01-05: 01 25 E4 9D AA  
06-10: C2 B5 E4 9D 55
```

▲ Figure 6.14 Communication Data

## 6.4.9 Warning Message

The display shows the 100 latest warn messages (see Figure 6.15). Screens can be scrolled manually by pressing the UP/ DOWN keys. Press the ESC key to return to the previous menu.

```
Msg000:  
T: 00-00 00:00 D: 0000
```

▲ Figure 6.15 Warning Message

## 6.5 Advanced Settings - Technicians Only



### NOTE:

To access to this area is for fully qualified and accredited technicians only. Please follow 6.4 to enter password to access this menu.

Select Advanced Settings from the Main Menu to access the following options:

1. Select Standard
2. Grid ON/OFF
3. Clear Energy
4. Reset Password
5. Power Control
6. Calibrate Energy
7. Special Settings
8. STD. Mode Settings
9. Restore Settings
10. HMI Update
11. External EPM Set
12. Restart HMI
13. Debug Parameter
14. DSP Update
15. Power Parameter

### 6.5.1 Selecting Standard

This function is used to select the grid's reference standard (see Figure 6.16).

```
YES=<ENT> NO=<ESC>  
Standard:AS4777-02
```

▲ Figure 6.16

Press the UP/DOWN keys to select the standard (AS4777-02, AS4777-15, VDE4105, VDE0126, UL-240V-A, UL-208V-A, UL-240V, UL-208V, MEX-CFE, G83/2 (for 1-3.6kW models), G59/3 (for 4-5kW models), C10/11, EN50438 DK, EN50438 IE, EN50438 NL and "User-Def" function).



### NOTE:

This function is for technicians use only.



### NOTE:

For different countries, the grid standard needs to be set as different according to local requirements. If there is any doubt, please consult Solis service technicians for details.

Selecting the "User-Def" menu will access to the following submenu (see Figure 6.17),

```
- OV-G-V1: 260V  
OV-G-V1-T: 1S
```

▲ Figure 6.17



### NOTE:

The "User-Def" function can be only used by the service engineer and must be allowed by the local energy supplier.

# 6. Operation

# 6. Operation

Below is the setting range for "User-Def".

Using this function, the limits can be changed manually.

OV-G-V1: 240---270V	OV-G-F1: 50.2-53Hz(60.2-64Hz)
OV-G-V1-T: 0.1---9S	OV-G-F1-T: 0.1---9S
OV-G-V2: 240---300V	OV-G-F2: 50.2-53Hz(60.2-64Hz)
OV-G-V2-T: 0.1---1S	OV-G-F2-T: 0.1---9S
UN-G-V1: 170---210V	UN-G-F1: 47-49.5Hz(56-59.8Hz)
UN-G-V1-T: 0.1---9S	UN-G-F1-T: 0.1---9S
UN-G-V2: 110---210V	UN-G-F2: 47-49Hz(56-59.8Hz)
UN-G-V2-T: 0.1---1S	UN-G-F2-T: 0.1---9S
Startup-T: 10-600S	Restore-T: 10-600S

## 6.5.2 Grid ON/OFF

This function is used to start up or stop the power generation of Solis Single Phase Inverter.



▲ Figure 6.18 Set Grid ON/OFF

Screens can be scrolled manually by pressing the UP/DOWN keys. Press the ENTER key to save the setting. Press the ESC key to return to the previous menu.

## 6.5.3 Clear Energy

Clear Energy can reset the history yield of inverter



These two functions are applicable by maintenance personnel only, wrong operation will prevent the inverter from working properly.

## 6.5.4 Reset Password

This function is used to set the new password for menu "Advanced info." and "Advanced information" (see Figure 6.19).



▲ Figure 6.19 Reset password

Enter the right password before set new password. Press the DOWN key to move the cursor, Press the UP key to revise the value. Press the ENTER key to execute the setting. Press the ESC key to return to the previous menu.

## 6.5.5 Power Control

Active and reactive power can be set through power setting button.

There are 5 item for this sub menu:

1. Set output power
2. Set Reactive Power
3. Out\_P With Restore
4. Rea\_P With Restore
5. Select PF Curve



This function is applicable by maintenance personnel only, wrong operation will prevent the inverter from reaching maximum power.

## 6.5.6 Calibrate Energy

Maintenance or replacement could clear or cause a different value of total energy. Use this function could allow user to revise the value of total energy to the same value as before. If the monitoring website is used the data will be synchronous with this setting automatically. (see Figure 6.20).



▲ Figure 6.20 Calibrate energy

Press the DOWN key to move the cursor, Press the UP key to revise the value. Press the ENTER key to execute the setting. Press the ESC key to return to the previous menu.



# 6. Operation

# 6. Operation

## 6.5.7 Special Settings



This function is applicable by maintenance personnel only, wrong operation will prevent the inverter from working properly.

## 6.5.8 STD. Mode Settings

There are 5 setting under STD. Mode settings.

1. Working mode
2. Power Rate limit
3. Freq. Derate set
4. 10mins OV-G-V set.
5. Initial Settings



This function is applicable by maintenance personnel only, wrong operation will prevent the inverter from working properly.

## 6.5.9 Restore Settings

Restore setting could set all item in 6.5.7 special setting to default. The screen shows as below:

Are you sure?  
YES=<ENT> NO=<ESC>

▲ Figure 6.21 Restore Settings

Press the Enter key to save the setting after setting grid off.

Press the ESC key to return the previous mean.

## 6.5.10 HMI Update

This function is used for update the LCD program.



This function is applicable by maintenance personnel only, wrong operation will prevent the inverter from reaching maximum power.

## 6.5.11 External EPM Set

This setting should only be turned on when Solis external EPM device is used.

Two options are available : 5G-EPM and Others-EPM.

->5G-EPM  
Others-EPM

▲ Figure 6.22

5G-EPM Failsafe Option should be turned ON when 5G series EPM device is used

Others-EPM Failsafe Option should be turned ON when 2G series EPM device is used

Only one option can be activated each time.

## 6.5.12 Restart HMI

The function is used for restart the HMI.



This function is applicable by maintenance personnel only, wrong operation will prevent the inverter from reaching maximum power.

## 6.5.13 Debug Parameter

This function is used for manufacturer maintenance personnel only.

## 6.5.14 DSP Update

The function is used for update the DSP.



This function is applicable by maintenance personnel only, wrong operation will prevent the inverter from reaching maximum power.

## 6.5.15 Power Parameter

This function is used for calibrate inverter output energy. It will not impact the energy count for inverter with RGM.

The screen shows:



```
YES=<ENT> NO=<ESC>
Power para: 1. 000
```

▲ Figure 6.23 Power Rate Limit

Press the Down key to move the cursor.

Press the Up key to change the digit.

Please press the Enter to save the setting and press the ESC key to return to the previous menu.



This setting is used for grid operator, don't change setting under this manual.

## 6.6 AFCI function

Solis inverters have the built-in AFCI function which can detect the arc fault on the DC circuit and shut down the inverter to prevent a fire disaster.

### 6.6.1 Enable the AFCI function

The AFCI function can be enabled in the following.

Path:

Advanced Setting -> Password: 0010 -> Special Settings -> AFCI Set -> AFCI ON/OFF -> ON

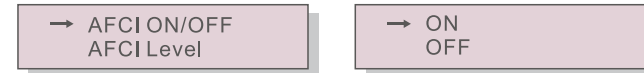

▲ Figure 6.24 Set AFCI



#### Warning:

The "AFCI Level" is reserved for Solis technicians ONLY. Do not change the sensitivity otherwise it will lead to frequent false alarms or malfunctions. Solis is not responsible for any further damages caused by unauthorized modifications.



#### NOTE:

The setting corresponds to the current status as well which can be used to inspect the ON/OFF state of the AFCI function.

### 6.6.2 Arc Fault

During the normal operation, if an DC arc is detected, the inverter will shut down and give out the following alarm:



```
ARC-FAULT
Restart Press ESC 3s
```

▲ Figure 6.25 Arc Fault

Installer needs to thoroughly inspect the DC circuit to ensure all the cables are correctly fastened.

Once the DC circuit issue has been fixed or it is confirmed to be OK, press "ESC" for 3s and wait for the inverter to restart.

# 7. Maintenance

## 7. Maintenance

Solis Single Phase 4G Inverter does not require any regular maintenance. However, cleaning the dust on heat-sink will help the inverter to dissipate the heat and increase its life time.

The dust can be removed with a soft brush.



**CAUTION:**

Do not touch the inverter's surface when it is operating. Some parts of the inverter may be hot and cause burns. Turn off the inverter (refer to Section 5.2) and wait for a cool-down period before any maintenance or cleaning operation.

The LCD and the LED status indicator lights can be cleaned with a damp cloth if they are too dirty to be read.



**NOTE:**

Never use any solvents, abrasives or corrosive materials to clean the inverter.

# 8. Troubleshooting

The inverter is designed in accordance with the most important international grid-tied standards and safety and electromagnetic compatibility requirements. Before delivering to the customer, the inverter has been subjected to several tests to ensure its optimal operation and reliability.

In case of failure, the LCD screen will display an alarm message. In this case, the inverter may stop feeding into the grid. The failure descriptions and their corresponding alarm messages are listed in Table 8.1:

# 8. Trouble Shooting

Alarm Message	Failure description	Solution
No power	Inverter no power on LCD	1. Check PV input connections 2. Check DC input voltage (single phase >120V, three phase >350V) 3. Check if PV+/- is reversed
LCD show initializing all the time	can not start-up	1. Check if the connector on main board or power board are fixed. 2. Check if the DSP connector to power board are fixed.
OV-G-V01/02/03/04	Over grid voltage	1. Resistant of AC cable is too high. Change bigger size grid cable 2. Adjust the protection limit if it's allowed by electrical company.
UN-G-V01/02	Under grid voltage	1. Use user define function to adjust the protection limit if it's allowed by electrical company.
OV-G-F01/02	Over grid frequency	
UN-G-F01/02	Under grid frequency	
Reverse-GRID	Wrong AC polarity	1. Check the polarity of AC connector.
Reverse-DC	Reverse DC polarity	1. Check the polarity of DC connector.
NO-GRID	No grid voltage	1. Check connections and grid switch. 2. Check the grid voltage inside inverter terminal.
OV-DC01/02/03/04	Over DC voltage	1. Reduce the module number in series
OV-BUS	Over DC bus voltage	1. Check inverter inductor connection 2. Check driver connection
UN-BUS01/02	Under DC bus voltage	
GRID-INTF01/02	Grid interference	1. Restart inverter 2. Change power board
OV-G-I	Over grid current	
IGBT-OV-I	Over IGBT current	
DC-INTF OV-DCA-I	DC input overcurrent	1. Restart inverter 2. Identify and remove the string to the fault MPPT 2. Change power board
IGFOL-F	Grid current tracking fail	1. Restart inverter or contact installer.
IG-AD	Grid current sampling fail	
OV-TEM	Over Temperature	1. Check inverter surrounding ventilation. 2. Check if there's sunshine direct on inverter in hot weather.
INI-FAULT	Initialization system fault	1. Restart inverter or contact installer.
DSP-B-FAULT	Comm. failure between main and slave DSP	
12Power-FAULT	12V power supply fault	
PV ISO-PRO 01/02	PV isolation protection	1. Remove all DC input, reconnect and restart inverter one by one. 2. Identify which string cause the fault and check the isolation of the string.

# 8. Trouble Shooting

Alarm Message	Failure description	Solution
ILeak-PRO 01/02/03/04	Leakage current protection	1.Check AC and DC connection 2.Check inverter inside cable connection.
RelayChk-FAIL	Relay check fail	1.Restart inverter or contact installer.
DCinj-FAULT	High DC injection current	1.Restart inverter or contact installer.
Screen OFF with DC applied	Inverter internally damaged	1.Do not turn off the DC switches as it will damage the inverter. 2.Please wait for the solar irradiance reduces and confirm the string current is less than 0.5A with a clip-on ammeter and then turn off the DC switches. 3.Please note that any damages due to wrong operations are not covered in the device warranty.
AFCI self-detection (model with AFCI module)	AFCI module self-detect fault	1.Restart inverter or connect technician.
Arcing protection (model with AFCI module)	Detect arc in DC circuit	1. Check inverter connection whether arc exists and restart inverter.

Table 8.1 Fault message and description



**NOTE:**

If the inverter displays any alarm message as listed in Table 8.1; please turn off the inverter (refer to Section 5.2 to stop your inverter) and wait for 5 minutes before restarting it (refer to Section 5.1 to start your inverter). If the failure persists, please contact your local distributor or the service center. Please keep ready with you the following information before contacting us.

1. Serial number of Solis Single Phase Inverter;
2. The distributor/dealer of Solis Single Phase Inverter (if available);
3. Installation date.
4. The description of problem (i.e. the alarm message displayed on the LCD and the status of the LED status indicator lights. Other readings obtained from the Information submenu (refer to Section 6.2) will also be helpful.);
5. The PV array configuration (e.g. number of panels, capacity of panels, number of strings, etc.);
6. Your contact details.

# 9. Specifications

Model	Solis-1P6K3-4G
Max. DC input voltage (Volts)	600
Rated DC voltage (Volts)	330
Startup voltage (Volts)	120
MPPT voltage range (Volts)	100-500
Max. input current (Amps)	10/10/10
Max short circuit input current (Amps)	15.6/15.6/15.6
MPPT number/Max input strings number	3/3
Rated output power (Watts)	6000
Max. output power (Watts)	6600
Max. apparent output power (VA)	6600
Rated grid voltage (Volts)	1/N/PE, 220/230
Rated output current (Amps)	27.3/26.1
Max. output current (Amps)	28.8
Power Factor (at rated output power)	> 0.99 (0.8 leading - 0.8 lagging)
THDi (at rated output power)	< 1.5%
Rated grid frequency (Hertz)	50/60
Operating frequency range (Hertz)	45-55 or 55-65
Max. efficiency	98.1%
EU efficiency	97.6%
Dimensions	333W*573H*249D (mm)
Weight	18kg
Topology	Transformerless
Self consumption (night)	< 1 W
Operating ambient temperature range	-25°C~+60°C
Relative humidity	0-100%
Ingress protection	IP65
Noise emission (typical)	<30 dB(A)
Cooling concept	Natural convection
Max.operation altitude	2000m
Grid connection standard	G98 or G99, VDE-AR-N 4105 / VDE V 0124, EN 50549-1, VDE 0126 / UTE C 15 / VFR:2019, RD 1699 / RD 244 / UNE 206006 / UNE 206007-1, CEI 0-21, C10/11, NRS 097-2-1, EIFS 2018.2, IEC 62116, IEC 61727, IEC60068, IEC 61683, EN 50530
Safety/EMC standard	IEC/EN 62109-1/-2, IEC/EN 61000-6-1/-2/-3/-4
DC connection	MC4 connector
AC connection	Quick connection plug
Display	LCD, 2×20 Z.
Communication connections	RS485, Optional: Wi-Fi, GPRS
Warranty Terms	5 Years (Extend to 20 Years)

## 9. Specifications

Model	Solis-1P7K-4G
Max. DC input voltage (Volts)	600
Rated DC voltage (Volts)	330
Startup voltage (Volts)	120
MPPT voltage range (Volts)	100-500
Max. input current (Amps)	10/10/10
Max short circuit input current (Amps)	15.6/15.6/15.6
MPPT number/Max input strings number	3/3
Rated output power (Watts)	7000
Max. output power (Watts)	7700
Max. apparent output power (VA)	7700
Rated grid voltage (Volts)	1/N/PE, 220/230
Rated output current (Amps)	31.8/30.4
Max. output current (Amps)	33.7
Power Factor (at rated output power)	> 0.99 (0.8 leading - 0.8 lagging)
THDi (at rated output power)	< 1.5%
Rated grid frequency (Hertz)	50/60
Operating frequency range (Hertz)	45-55 or 55-65
Max. efficiency	98.1%
EU efficiency	97.6%
Dimensions	333W*573H*249D (mm)
Weight	18kg
Topology	Transformerless
Self consumption (night)	< 1 W
Operating ambient temperature range	-25°C~+60°C
Relative humidity	0-100%
Ingress protection	IP65
Noise emission (typical)	<30 dB(A)
Cooling concept	Natural convection
Max.operation altitude	2000m
Grid connection standard	G98 or G99, VDE-AR-N 4105 / VDE V 0124, EN 50549-1, VDE 0126 / UTE C 15 / VFR:2019, RD 1699 / RD 244 / UNE 206006 / UNE 206007-1, CEI 0-21, C10/11, NRS 097-2-1, EIFS 2018.2, IEC 62116, IEC 61727, IEC60068, IEC 61683, EN 50530
Safety/EMC standard	IEC/EN 62109-1/-2, IEC/EN 61000-6-1/-2/-3/-4
DC connection	MC4 connector
AC connection	Quick connection plug
Display	LCD, 2×20 Z.
Communication connections	RS485, Optional: Wi-Fi, GPRS
Warranty Terms	5 Years (Extend to 20 Years)

## 9. Specifications

Model	Solis-1P8K-4G
Max. DC input voltage (Volts)	600
Rated DC voltage (Volts)	330
Startup voltage (Volts)	120
MPPT voltage range (Volts)	100-500
Max. input current (Amps)	10/10/10
Max short circuit input current (Amps)	15.6/15.6/15.6
MPPT number/Max input strings number	3/3
Rated output power (Watts)	8000
Max. output power (Watts)	8800
Max. apparent output power (VA)	8800
Rated grid voltage (Volts)	1/N/PE, 220/230
Rated output current (Amps)	36.4/34.8
Max. output current (Amps)	36.6
Power Factor (at rated output power)	> 0.99 (0.8 leading - 0.8 lagging)
THDi (at rated output power)	< 1.5%
Rated grid frequency (Hertz)	50/60
Operating frequency range (Hertz)	45-55 or 55-65
Max. efficiency	98.1%
EU efficiency	97.6%
Dimensions	333W*573H*249D (mm)
Weight	18kg
Topology	Transformerless
Self consumption (night)	< 1 W
Operating ambient temperature range	-25°C~+60°C
Relative humidity	0-100%
Ingress protection	IP65
Noise emission (typical)	<30 dB(A)
Cooling concept	Natural convection
Max.operation altitude	2000m
Grid connection standard	G98 or G99, VDE-AR-N 4105 / VDE V 0124, EN 50549-1, VDE 0126 / UTE C 15 / VFR:2019, RD 1699 / RD 244 / UNE 206006 / UNE 206007-1, CEI 0-21, C10/11, NRS 097-2-1, EIFS 2018.2, IEC 62116, IEC 61727, IEC60068, IEC 61683, EN 50530
Safety/EMC standard	IEC/EN 62109-1/-2, IEC/EN 61000-6-1/-2/-3/-4
DC connection	MC4 connector
AC connection	Quick connection plug
Display	LCD, 2×20 Z.
Communication connections	RS485, Optional: Wi-Fi, GPRS
Warranty Terms	5 Years (Extend to 20 Years)

## 9. Specifications

Model	Solis-1P9K-4G
Max. DC input voltage (Volts)	600
Rated DC voltage (Volts)	330
Startup voltage (Volts)	120
MPPT voltage range (Volts)	100-500
Max. input current (Amps)	10/10/10
Max short circuit input current (Amps)	15.6/15.6/15.6
MPPT number/Max input strings number	3/3
Rated output power (Watts)	9000
Max. output power (Watts)	9900
Max. apparent output power (VA)	9900
Rated grid voltage (Volts)	1/N/PE, 220/230
Rated output current (Amps)	40.9/39.1
Max. output current (Amps)	41.3
Power Factor (at rated output power)	> 0.99 (0.8 leading - 0.8 lagging)
THDi (at rated output power)	< 1.5%
Rated grid frequency (Hertz)	50/60
Operating frequency range (Hertz)	45-55 or 55-65
Max. efficiency	98.1%
EU efficiency	97.6%
Dimensions	333W*573H*249D (mm)
Weight	18kg
Topology	Transformerless
Self consumption (night)	< 1 W
Operating ambient temperature range	-25°C~+60°C
Relative humidity	0-100%
Ingress protection	IP65
Noise emission (typical)	<30 dB(A)
Cooling concept	Natural convection
Max.operation altitude	2000m
Grid connection standard	G98 or G99, VDE-AR-N 4105 / VDE V 0124, EN 50549-1, VDE 0126 / UTE C 15 / VFR:2019, RD 1699 / RD 244 / UNE 206006 / UNE 206007-1, CEI 0-21, C10/11, NRS 097-2-1, EIFS 2018.2, IEC 62116, IEC 61727, IEC60068, IEC 61683, EN 50530
Safety/EMC standard	IEC/EN 62109-1/-2, IEC/EN 61000-6-1/-2/-3/-4
DC connection	MC4 connector
AC connection	Quick connection plug
Display	LCD, 2×20 Z.
Communication connections	RS485, Optional: Wi-Fi, GPRS
Warranty Terms	5 Years (Extend to 20 Years)

## 9. Specifications

Model	Solis-1P10K-4G
Max. DC input voltage (Volts)	600
Rated DC voltage (Volts)	330
Startup voltage (Volts)	120
MPPT voltage range (Volts)	100-500
Max. input current (Amps)	10/10/10
Max short circuit input current (Amps)	15.6/15.6/15.6
MPPT number/Max input strings number	3/3
Rated output power (Watts)	10000
Max. output power (Watts)	10000
Max. apparent output power (VA)	10000
Rated grid voltage (Volts)	1/N/PE, 220/230
Rated output current (Amps)	45.5/43.5
Max. output current (Amps)	45.9
Power Factor (at rated output power)	> 0.99 (0.8 leading - 0.8 lagging)
THDi (at rated output power)	< 1.5%
Rated grid frequency (Hertz)	50/60
Operating frequency range (Hertz)	45-55 or 55-65
Max. efficiency	98.1%
EU efficiency	97.6%
Dimensions	333W*573H*249D (mm)
Weight	18kg
Topology	Transformerless
Self consumption (night)	< 1 W
Operating ambient temperature range	-25°C~+60°C
Relative humidity	0-100%
Ingress protection	IP65
Noise emission (typical)	<30 dB(A)
Cooling concept	Natural convection
Max.operation altitude	2000m
Grid connection standard	G98 or G99, VDE-AR-N 4105 / VDE V 0124, EN 50549-1, VDE 0126 / UTE C 15 / VFR:2019, RD 1699 / RD 244 / UNE 206006 / UNE 206007-1, CEI 0-21, C10/11, NRS 097-2-1, EIFS 2018.2, IEC 62116, IEC 61727, IEC60068, IEC 61683, EN 50530
Safety/EMC standard	IEC/EN 62109-1/-2, IEC/EN 61000-6-1/-2/-3/-4
DC connection	MC4 connector
AC connection	Quick connection plug
Display	LCD, 2×20 Z.
Communication connections	RS485, Optional: Wi-Fi, GPRS
Warranty Terms	5 Years (Extend to 20 Years)

## 10.1 Grid standard selection guide



**NOTE:**

Please check if the grid code setting comply with local requirement.

For different countries and regions, corresponding grid code needs to be selected in the inverter LCD to meet the requirements of local network provider.

This instruction indicates how to change the grid code and what code should be selected in different places.

This following list illustrates the grid standard options in the inverter which are subject to change. It is for your reference only. If customer has any doubts or uncertainty, please consult Solis service department for confirmation.

To set the correct grid code, please enter the following path:

Advanced Settings -> Password:0010 -> Select Standard

Detailed protection limits can be viewed when choosing the code.

Please select "Save&Send" to enforce the code.

NO.	Code in LCD	Country/Region	Comments
1	VDE4015	Germany	For German Low Voltage Grid.
2	EN50549 PO	Poland	For Polish Low Voltage Grid
3	EN50549 NL	Netherland	For Dutch Low Voltage Grid
4	EN50438 L	-	General EN50438 Requirement. Possible to be used in Austria, Cyprus, Finland, Czech Republic, Slovenia, etc.
5	EIFS- SW	Sweden	For Swedish Low Voltage Grid
6	France	France	For French Low Voltage Grid
7	C10/11	Belgium	For Belgian Low Voltage Grid
8	NRS097	South Africa	For South African Low Voltage Grid
9	CEI0-21	Italy	For Italian Low Voltage Grid
10	EN50549L (EN50549-1)	-	General EN50549-1 requirement which meets local requirements of most European countries
11	G98	UK	For UK Low Voltage Grid <16A
12	G99	UK	For UK Low Voltage Grid >16A

NO.	Code in LCD	Country/Region	Comments
13	G98 NI	North Ireland	For North Ireland Low Voltage Grid <16A
14	G99 NI	North Ireland	For North Ireland Low Voltage Grid >16A
15	User-define	-	Customized Protection Limits
16	Gen50	-	Generator Connected, Frequency-Derating, 50Hz
17	Gen 60	-	Generator Connected, Frequency-Derating, 60Hz
18	DK1	East Denmark	For East Danish low voltage grid
19	DK2	West Denmark	For West Danish low voltage grid
20	50438IE	Ireland	For Irish low voltage grid
21	RD1699	Spain	For Spanish low voltage grid
22	EN50549	-	General EN50549 Requirement. Possible to be used in Cyprus, Finland, Czech Republic, Slovenia, Jamaica